

NON-MYDRIATIC FUNDUS CAMERA TFC-1000

FULLY AUTOMATED FUNDUS CAMERA



- Automatic eye tracking
- Auto focus & auto measurement
- Fundus image within 15 seconds
- Multi imaging display
- Field of view 45° x 45°
- 12M pixel sensor
- 9 fixation points
- Anterior segment imaging



NON-MYDRIATIC FUNDUS CAMERA TFC-1000



QUALITY IN DETAIL

The **TFC-1000** fully automatically generates a fundus image within 15 seconds using eye tracking and auto focus as well as auto measurement. The “KISS principle” (keep it short and simple) had the highest priority in the software and workflow design. This makes the operation of the **TFC-1000** extremely easy to handle. The user-friendly interface is very intuitive and provides the results in a very short time.

MULTI IMAGING DISPLAY

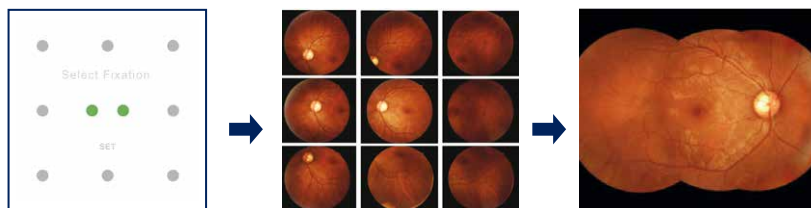

With 9 fixation points we enlarge the field of vision (FOV) of the retinal image. For multi imaging you have the possibility to select 3 of 9 points. The FOV will extend from 45° to 80°.

SPECIFICATIONS

FEATURES AND FUNCTIONS

Type	Digital non-mydratic retina camera
Type of photography	Colour, digital red-free, anterior eye image
Light source	Observation light source: Infrared LED Flash light source: White LED
Auto exposure	YES
Auto focusing	YES
Image	12 MP
Image resolution	4096 x 3072
Alignment	Fully automatic 3D tracking
Chinrest	Motorised

MEASUREMENT

Field of view	45° x 45° up to 80°
Minimum pupil size	3.8 mm
Working distance	25 mm
Focus adjustment range	-15D to +10D (without compensation lens) -35D to +30D (with compensation lens)
Flash intensity	10 levels, can be set manually
Eye fixation	Internal ten points

NETWORKING CAPABILITY

Interface	USB2.0, Ethernet, HDMI, WiFi
Image format	JPEG, PNG, DICOM

OPERATING ENVIRONMENT

Temperature	10°C to 35°C
Humidity	30% to 90% (no condensation)

DIMENSIONS & ELECTRICAL REQUIREMENTS

Dimension WDH	282 x 485 x 492 mm
Weight	17 kg
Voltage	AC100V to 240V
Frequency	50/60Hz
Power consumption	< 150W

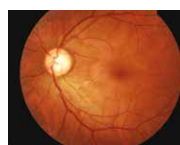

Colour



Digital red free

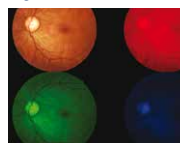

RGB

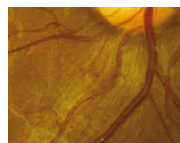

Zoom to see tiny details

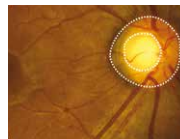

Cup-to-disc



Corneal image

TFC-1000 VIEWER SOFTWARE

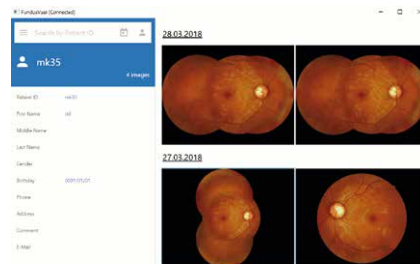

With the viewer software you can analyse the diagnostics of the images.

EXTERNAL ANALYSIS (OPTIONAL)

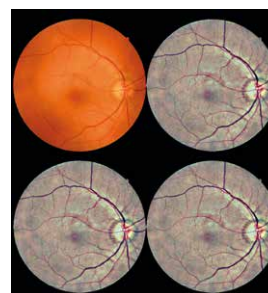

Fundus images can be send to external diagnostic supplier for screening. The images can also be transferred to our Perimeter for target Perimetry.

DIMENSIONS

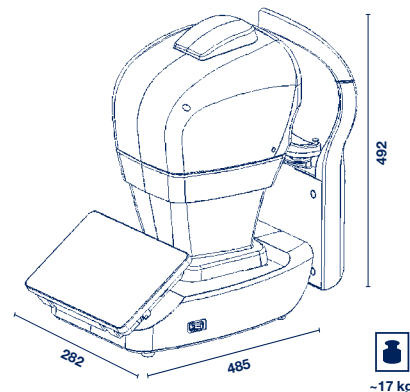

2022/01 - subject to change without notice



TOMEY EUROPE
TOMEY GmbH
Wiesbadener Strasse 21
90427 Nürnberg, Germany
Phone +49 911 938 546 2 0
Fax +49 911 938 546 2 20
Email info@tomey.de

TOMEY ASIA-PACIFIC
TOMEY CORPORATION JAPAN
2-11-33 Noritakeshinmachi
Nishi-ku, Nagoya 451-0051, Japan
Phone +81 52 581 5327
Fax +81 52 561 4735
Email intl@tomey.co.jp



www.tomey.de